

Features

- Meet the Requirements of the EIA/TIA-485 Standards with 3.3V Power Supply and Integrated Transient Voltage Suppressor (TVS)
- TVS Protection for Bus Terminals :
±15 kV IEC 61000-4-2, Contact Discharge
±18 kV IEC 61000-4-2, Air-Gap Discharge
±15 kV EIA/JEDEC Human Body Model
- HBM ±8kV ESD Protection for all pins
- MM ±800V ESD Protection for all pins
- Latchup immunity up to ±400mA for all pins.
- High CDM protection up to ±1kV for all pins..
- Enhanced Slew-Rate Limiting Facilitates Error-Free Data Transmission
- True Fail-Safe Receiver While Maintaining EIA/TIA-485 Compatibility
- Hot-Swap Glitch free Protection on Control Inputs
- Up to 256 Transceivers on the Bus

Applications

- Telecommunications Equipment
- Security System
- Industrial Control
- Building Automation Networks

Description

The AZRS7032P is a ±15kV IEC 61000-4-2 contact discharge protected half-duplex RS485 transceiver IC, which contains one transmitter and one receiver inside. This device is fully compliant with the EIA/TIA-485 standard with 3.3V power supply.

The AZRS7032P features a fail-safe receiver, which guarantees the output of the receiver to be logic high when the differential inputs (bus pins, A and B) of the receiver are open, short or idle conditions.

The AZRS7032P has a slew-rate-limited transmitter to minimize EMI and reflection caused by improperly cable terminated.

The AZRS7032P features a hot-swap glitch-free which guarantees outputs of the transmitter and the receiver in a high impedance state and even no short current event during the power up period. The AZRS7032P has the thermal shutdown and the current limited function in the transmitter to protect the device from damage by system fault condition during normal operating condition. The AZRS7032P is designed 1/8 unit load with minimum 96kΩ of input impedance, which can connect 256 devices on a bus at most. The AZRS7032P is also a high reliable device with built-in system level ESD protected devices against high-energy noise transients without any external components.

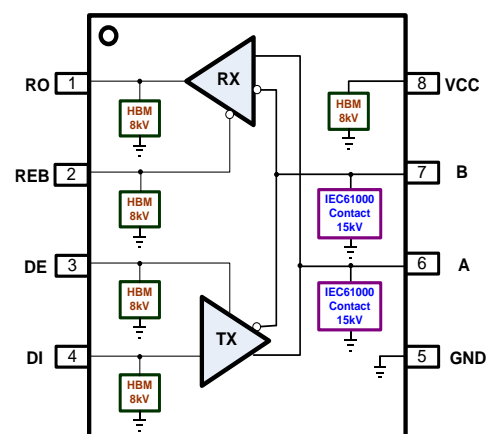

Functional Block of AZRS7032P

Part Number	Duplex	Tx/Rx	Supply (V)	Data Rate (Kbps)	Slew-Rate	Fail-Safe	HBM/MM (V)	IEC 61000-4-2 Contact (V)	Package Type
AZRS7032P	Half	1/1	3.3	250	Yes	Yes	8K/800	± 15k	SO-8



ABSOLUTE MAXIMUM RATINGS

PARAMETER	PARAMETER	RATING	UNITS
Power Supply Vcc	Vcc	-0.3 to 7.0	V
Control Input Voltage	REB, DE	-0.3 to (Vcc+ 0.3)	V
Receiver Input Voltage	A, B	±13	V
Receiver Output Voltage	RO	-0.3 to (Vcc+ 0.3)	V
Transmitter Output Voltage	A, B	±13	V
Transmitter Input	DI	-0.3 to (Vcc+ 0.3)	V
Operating Temperature	T _{OP}	-40 to +85	°C
Storage Temperature	T _{STO}	-65 to +150	°C

DC ELECTRICAL CHARACTERISTICS

(Vcc=3.3V±5% with T_{AMB}= T_{MIN} to T_{MAX}, unless otherwise noted. Typical values are at Vcc=3.3V and T_{AMB}= 25 °C.)

PARAMETER	SYMBOL	CONDITIONS	MIN	TYP	MAX	UNITS
Transmitter						
Differential Transmitter Output	V _{OD1}	No load			Vcc	V
Differential Transmitter Output	V _{OD2}	Fig.1, R _L = 27 Ω	1.5			V
Change in Magnitude of Differential Output Voltage	ΔV _{OD}	Fig.1, R _L = 27 Ω			0.2	V
Transmitter Common- Mode Output Voltage	V _{OC}	Fig.1, R _L = 27 Ω			3	V
Change in Magnitude of Common- Mode Voltage	ΔV _{OC}	Fig.1, R _L = 27 Ω			0.2	V
Input High Voltage	V _{IH}	DE, DI, REB	2.0			V
Input Low Voltage	V _{IL}	DE, DI, REB			0.8	V
Input Current	I _{IN1}	DE, DI, REB			±2	μA
Input Current for A and B	I _{IN2}	DE=0, Vcc=0V or 3.5V	V _{IN} =12V		125	μA
			V _{IN} =-7V	-100		
Transmitter Short-Circuit Output Current	I _{OSD}	-7V ≤ V _{OUT} ≤ 12V	-250		250	mA



PARAMETER	SYMBOL	CONDITIONS	MIN	TYP	MAX	UNITS
RECEIVER						
Receiver Differential Threshold Voltage	V_{TH}		-200		-50	mV
Receiver Output High Voltage	V_{OH}	$I_o = -1mA, VID = 200mV$	$V_{CC} - 0.6$			V
Receiver Output Low Voltage	V_{OL}	$I_o = 1mA, VID = -200mV$			0.4	V
Three- State Output Current at Receiver	I_{OZR}	$0 \leq V_{RO} \leq V_{CC}$			± 1	μA
Receiver Input Resistance	R_{IN}	$-7V \leq V_{CM} \leq +12V$	96			$k\Omega$
Receiver Output Short-Circuit Current	I_{OSR}	Fig. 6, $0V \leq V_{RO} \leq V_{CC}$			± 80	mA
SUPPLY CURRENT						
Supply Current	I_{CC}	No load, REB=0, DE= V_{CC}		400	900	μA
		No load, REB= V_{CC} , DE= V_{CC}		400	900	μA
		No load, REB=0, DE= 0		300	600	μA
Supply Current in Shutdown Mode	I_{SHDN}	REB= V_{CC} , DE= 0		1	10	μA
ESD PROTECTION						
ESD Protection for A and B		Human Body Model (HBM)		15		kV
		IEC 61000-4-2 Contact		15		kV
		IEC 61000-4-2 Air		18		kV

SWITCHING CHARACTERISTICS

($V_{CC} = 3.3V \pm 5\%$ with $T_{AMB} = T_{MIN}$ to T_{MAX} , unless otherwise noted. Typical values are at $V_{CC} = 3.3V$ and $T_{AMB} = 25^\circ C$.)

PARAMETER	SYMBOL	CONDITIONS	MIN	TYP	MAX	UNITS
Transmitter						
Transmitter Propagation Delay	t_{DPLH}, t_{DPHL}	Fig.2, Fig.7, $R_{DIFF} = 54\Omega$, $C_{L1} = C_{L2} = 100pF$	300		1600	ns
Transmitter Output Skew $ t_{DPLH} - t_{DPHL} $	t_{DSKEW}	Fig.2, Fig.7, $R_{DIFF} = 54\Omega$, $C_{L1} = C_{L2} = 100pF$			200	ns
Transmitter Rise or Fall Time	t_{DF}, t_{DR}	Fig.2, Fig.7, $R_{DIFF} = 54\Omega$, $C_{L1} = C_{L2} = 100pF$	350		1800	ns
Data Rate	f_{Data}				250	kbps



Transmitter Enable to Output Low	t _{DZL}	Fig.4, Fig.8, C _{DL} = 50pF, S1 closed			2500	ns
Transmitter Enable to Output High	t _{DZH}	Fig.4, Fig.8, C _{DL} = 50pF, S2 closed			2500	ns
Transmitter Disable Time from Low	t _{DLZ}	Fig.4, Fig.8, C _{DL} = 50pF, S1 closed			200	ns
Transmitter Disable Time from High	t _{DHZ}	Fig.4, Fig.8, C _{DL} = 50pF, S2 closed			200	ns
Transmitter Enable from Shutdown to Output Low	t _{DZL(SHDN)}	Fig.4, Fig.8, C _{DL} = 50pF, S1 closed			5500	ns
Transmitter Enable from Shutdown to Output High	t _{DZH(SHDN)}	Fig.4, Fig.8, C _{DL} = 50pF, S2 closed			5500	ns
Time to shutdown	t _{SHDN}		50	200	600	ns
Receiver						
Receiver Input to Output	t _{RPLH} , t _{RPHL}	Fig.5, Fig.9, V _{ID} ≥ 2.0V; rise and fall time of V _{ID} ≤ 15ns			200	ns
$ t_{RPLH} - t_{RPHL} $ Different Receiver Skew	t _{RSKD}	Fig.5, Fig.9, V _{ID} ≥ 2.0V; rise and fall time of V _{ID} ≤			30	ns
Data Rate	f _{Data}				250	kbps
Receiver Enable to Output Low	t _{RZL}	Fig.3, Fig.10, C _{RL} = 15pF, S1 closed			100	ns
Receiver Enable to Output High	t _{RZH}	Fig.3, Fig.10, C _{RL} = 15pF, S2 closed			100	ns
Receiver Disable Time from Low	t _{RLZ}	Fig.3, Fig.10, C _{RL} = 15pF, S1 closed			100	ns
Receiver Disable Time from High	t _{RHZ}	Fig.3, Fig.10, C _{RL} = 15pF, S2 closed			100	ns
Receiver Enable from Shutdown to Output Low	t _{RZL(SHDN)}	Fig.3, Fig.10, C _{RL} = 15pF, S1 closed			4000	ns
Receiver Enable from Shutdown to Output High	t _{RZH(SHDN)}	Fig.3, Fig.10, C _{RL} = 15pF, S2 closed			4000	ns
Time to shutdown	t _{SHDN}		50	200	600	ns



PIN FUNCTION DESCRIPTION

Pin Number	Mnemonic	Function
1	RO	Receiver Output: When REB is low and if $(A - B) \geq -50\text{mV}$, RO is high; if $(A - B) \leq -200\text{mV}$, RO is low.
2	REB	Receiver Output Enable: REB is low to enable the Receiver; REB is high to disable the Receiver.
3	DE	Transmitter Output Enable: DE is high to enable the transmitter; DE is low to disable the transceiver.
4	DI	Transmitter Input: When DE is high, a low on DI forces A output low and B output high. Similarly, a high on DI forces A output high and B output low.
5	GND	Ground.
6	A	Non-inverting Receiver Input and Non-inverting Transmitter Output.
7	B	Inverting Receiver Input and Inverting Transmitter Output.
8	VCC	Power Supply Input 3.3V. Must adding a 100nF decoupling capacitor as close to the VCC pin as possible.

FUNCTION TABLE

TRANSMITTING				
INPUTS			OUTPUTS	
REB	DE	DI	A	B
X	1	0	0	1
X	1	1	1	0
0	0	X	High- Z	High- Z
1	0	X	Shutdown	

X= Don't care
HIGH- Z= High impedance

RECEIVING			
INPUTS			OUTPUTS
REB	DE	A - B	RO
0	0	$\geq -0.05\text{V}$	1
0	0	$\leq -0.2\text{V}$	0
0	0	Open/Shorted	1
1	1	X	High- Z
1	0	X	Shutdown

X= Don't care
HIGH- Z= High impedance



Detail Description

The AZRS7032P is a half-duplex RS-485 transceiver IC with IEC61000-4-2 contact $\pm 15\text{kV}$ ESD protection for bus pins (A and B), which contains one transmitter and one receiver inside with 3.3V power supply. This device is fully compliant with the EIA/TIA-485 standard.

The AZRS7032P features the hot-swap glitch free design which guarantees the outputs of the transceiver in a high impedance state during the power-up period until the supply voltage has stabilized.

The AZRS7032P with whole chip ESD protected design for all of the I/O pins has robust ESD protection up to both HBM $\pm 8\text{kV}$ and MM $\pm 800\text{V}$. Moreover, the latchup immunity of the AZRS7032P is up to $\pm 400\text{mA}$ for all of the pins. For IC self discharge issue, the CDM protection level of the AZRS7032P is up to $\pm 1\text{kV}$.

Transmitter

The design of the transmitter is a non-inverted translator that converts the single-ended TTL input signal to differential EIA/TIA-485 signal level. The transmitter of the AZRS7032P has a slew-rate-limited driver to minimize EMI and reflection caused by improperly cable terminated. When the transmitter is active (DE= HIGH), the single-end TTL input signals of transmitter will be transported to differential output RS485 signals of the transmitter. Under the disable state (DE= LOW), the outputs of transmitter keep at high impedance state. The differential output voltage (VA-VB) of the AZRS7032P is at least 1.5V with 54Ω load under $T= 25^\circ\text{C}$.

Receiver

The receiver of the AZRS7032P converts the differential EIA/TIA-485 signals to single-end output TTL signal when receiver is in active state

(REB=LOW). When the receiver is disable (REB=HIGH), the output of the receiver keeps in high impedance state no matter what receiver input.

True Fail-Safe

In traditional design, the fail-safe function is implemented by resistors on the PCB. One resistor is terminated pin A to VCC; the other is terminated pin B to GND to keep RO at high state when bus is idle.

The AZRS7032P guarantees a receiver output high when the receiver inputs are short, open or idle, that is true fail-safe. The threshold voltage of receiver input is between -50mV and -200mV . If the differential input voltage (A - B) of receiver is greater than or equal to -50mV , receiver output (RO) is logic-high. If (A - B) is less than or equal to -200mV , RO is logic-low. In the case of a terminated bus with all transmitters disabled, the receiver's differential input voltage (A - B) is 0V, so the RO is logic-high at that time.

1/8 Unit Load

The AZRS7032P transceiver has a $96\text{k}\Omega$ input impedance (1/8 unit load) of the receiver, allowing up to 256 or fewer devices to be connected in parallel on the RS485 bus.

Transmitter Output Protection

The AZRS7032P has the current limitation function and the thermal shutdown protection in the transmitter. Firstly, the function of current limitation provides immediate protection against short circuits over the whole common-mode voltage range (-7V to $+12\text{V}$). Secondly, the function of thermal shutdown protection forces the transmitter outputs into a high impedance state if the die temperature becomes excessive.

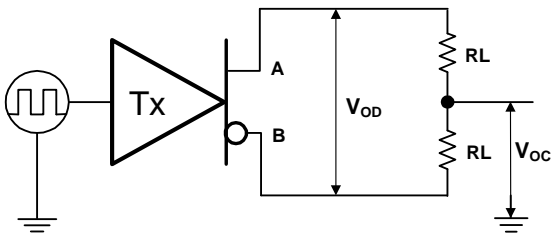

Fig.1 Transmitter DC test circuit

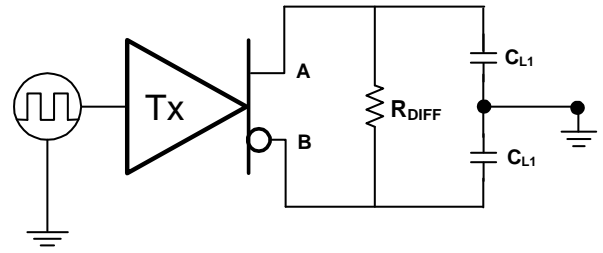

Fig.2 Transmitter timing test circuit

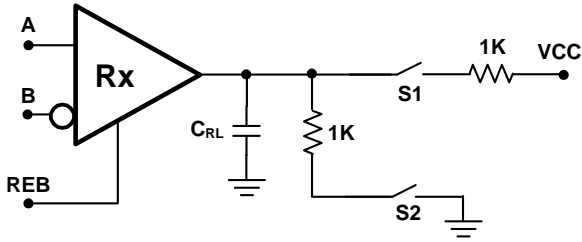

Fig.3 Receiver enable/disable timing test load

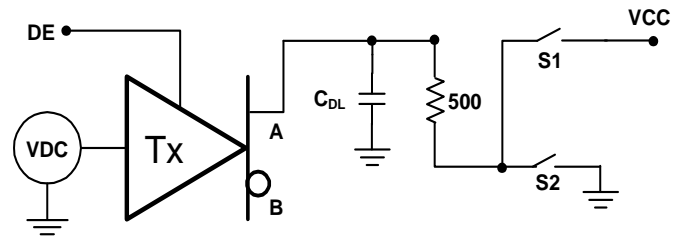

Fig.4 Transmitter enable/disable timing test load

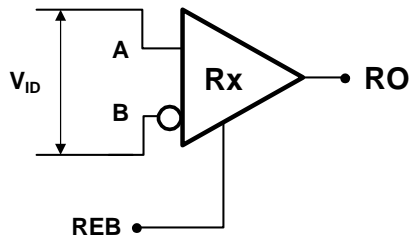

Fig.5 Receiver timing test circuit

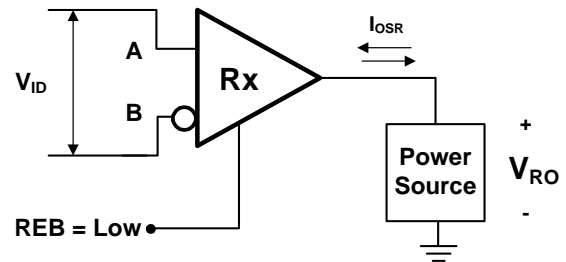

Fig.6 Receiver output short circuit

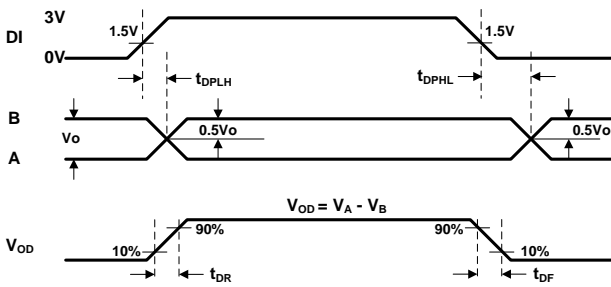

Fig.7 Transmitter Propagation Delays

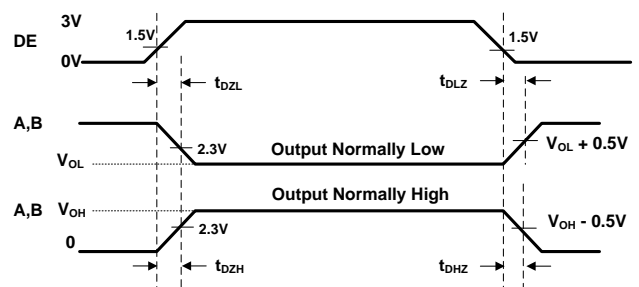

Fig.8 Transmitter Enable and Disable Times

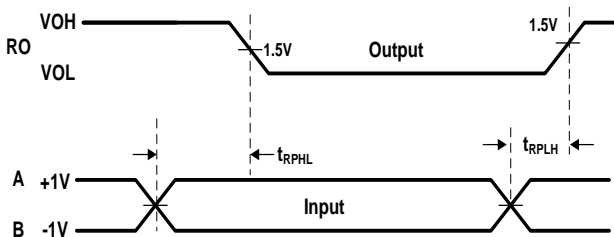

Fig.9 Receiver Propagation Delays

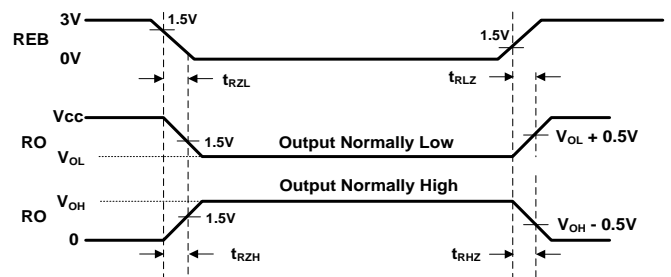
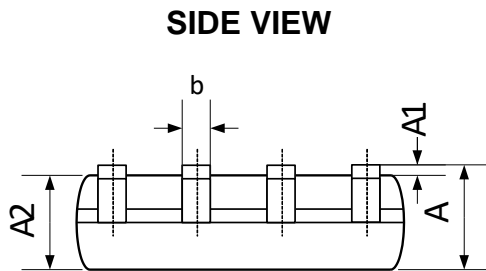
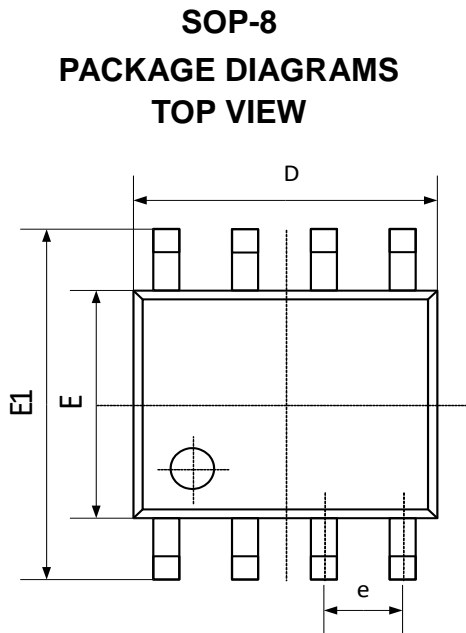

Fig.10 Receiver Enable and Disable Times



Mechanical Details



END VIEW

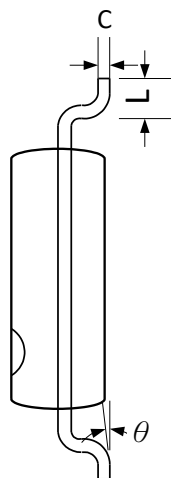

PACKAGE DIMENSIONS

Symbol	Millimeters		Inches	
	min	max	min	max
A	1.35	1.75	0.053	0.069
A1	0.10	0.25	0.004	0.010
A2	1.25	1.55	0.049	0.061
b	0.33	0.51	0.013	0.020
C	0.17	0.26	0.007	0.010
D	4.70	5.10	0.185	0.201
E	3.70	4.10	0.146	0.161
E1	5.80	6.20	0.228	0.244
e	1.27 BSC		0.05BSC	
L	0.40	1.27	0.016	0.050
Θ	0	8	0	8

MARKING CODE

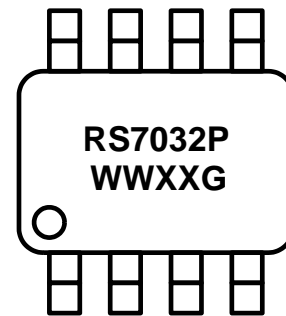

RS7032P = Device Code
WW = Date Code
XX = Control Code
G = Green Part Indication

Part Number	Marking Code
AZRS7032P.RDG	RS7032P WWXXG



Ordering Information

PN#	Material	Type	Reel size	MOQ	MOQ/internal box	MOQ/carton
AZRS7032P.RDG	Green	T/R	13 inch	2,500/reel	1 reel=2,500/box	5 box=12,500/carton

Revision History

Revision	Modification Description
Revision 2025/12/26	Formal Release.