

Features

- Meet the Requirements of the EIA/TIA-485 Standards with 5V Power Supply
- Integrated Transient Voltage Suppressor (TVS)
- TVS Protection for Bus Terminals :
 $\pm 30\text{kV}$, IEC 61000-4-2, Contact/Air Discharge
 $\pm 88\text{A}$, IEC 61000-4-4, EFT (5/50ns)
 $\pm 30\text{A}$, IEC 61000-4-5, Surge (8/20 μs)
- **HBM $\pm 15\text{kV}$** ESD Protection for all pins
- **MM $\pm 800\text{V}$** ESD Protection for all pins
- Latchup immunity up to **$\pm 400\text{mA}$** .
- High CDM protection up to **$\pm 2\text{kV}$** .
- True Fail-Safe Receiver While Maintaining EIA/TIA-485 Compatibility
- Hot-Swap Glitch Protection on Control Inputs
- Controlled Transmitter Slew-Rate
- 1nA Low Shutdown Current
- Up to 256 Transceivers on the Bus

Applications

- Energy Meter Networks
- Motor Control
- Industrial Control
- Telecommunications Equipment
- Security System
- Building Automation Networks

Description

The AZRS3082 is a $\pm 30\text{ kV}$ IEC 61000-4-2 Contact/Air Discharge protected, half-duplex transceiver which designed for RS-485 data bus network with one transmitter and one receiver.

The AZRS3082 is fully compliant with the EIA/TIA-485 standard under 5V supply. The AZRS3082 features a fail-safe receiver, which guarantees the output of receiver to logic high when the receiver inputs are open, short or idle. The AZRS3082 has a slew-rate-limited transmitter to minimize EMI and reflection caused by improperly cable terminated. The transmission speed of AZRS3082 is up to 115kbps with error-free operation. For the glitch free protection, hot-swap circuit of the AZRS3082 guarantees the outputs of both the transmitter and the receiver in a high impedance state during the power up period. Moreover, the transmitter of the AZRS3082 has the thermal shutdown and the current limited function to protect itself from damage of the system fault conditions during normal operation.

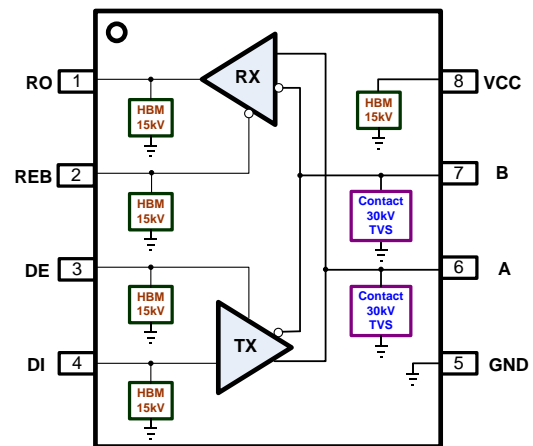

Functional Block of AZRS3082

Part Number	Duplex	Tx/Rx	Data Rate (kbps)	Slew Rate Limit	Rx Input Filtering	Low Power Shutdown	Tx/ Rx Enable	ESD on A,B	Package Type
AZRS3082	Half	1/1	115	Yes	Yes	Yes	Yes	$\pm 30\text{kV}$	SO-8

ABSOLUTE MAXIMUM RATINGS

PARAMETER	PARAMETER	RATING	UNITS
Power Supply Vcc	Vcc	-0.3 to 7.0	V
Control Input Voltage	REB, DE	-0.3 to (Vcc+ 0.3)	V
Receiver Input Voltage	A, B	± 13	V
Receiver Output Voltage	RO	-0.3 to (Vcc+ 0.3)	V
Transmitter Output Voltage	A, B	± 13	V
Transmitter Input	DI	-0.3 to (Vcc+ 0.3)	V
Operating Temperature	T _{OP}	-40 to +85	°C
Storage Temperature	T _{STO}	-65 to +150	°C

DC ELECTRICAL CHARACTERISTICS

(Vcc=5V $\pm 5\%$ with T_{AMB}= T_{MIN} to T_{MAX}, unless otherwise noted. Typical values are at Vcc=5V and T_{AMB}= 25 °C.)

PARAMETER	SYMBOL	CONDITIONS	MIN	TYP	MAX	UNITS
TRANSMITTER						
Differential Transmitter Output	V _{OD1}	No load			5	V
Differential Transmitter Output	V _{OD2}	Fig.1, R _L = 27 Ω	1.7			V
Change in Magnitude of Differential Output Voltage	ΔV_{OD}	Fig.1, R _L = 27 Ω			0.2	V
Transmitter Common- Mode Output Voltage	V _{OC}	Fig.1, R _L = 27 Ω			3	V
Change in Magnitude of Common- Mode Voltage	ΔV_{OC}	Fig.1, R _L = 27 Ω			0.2	V
Input High Voltage	V _{IH}	DE, DI, REB	2.0			V
Input Low Voltage	V _{IL}	DE, DI, REB			0.8	V
Input Current	I _{IN1}	DI			± 1	μA
Input Current	I _{IN2}	DE, REB			± 50	μA
DI Input Hysteresis	V _{HYS}			100		mV
Input Current (A and B)	I _{IN3}	DE = GND, VCC = GND or 5.25V	V _{IN} = 12V		125	μA
			V _{IN} = -7V		-75	
Transmitter Short-Circuit Output Current	I _{OS}	$-7\text{V} \leq V_{OUT} \leq V_{CC}$	-250			mA
		$0\text{V} \leq V_{OUT} \leq 12\text{V}$			250	



PARAMETER	SYMBOL	CONDITIONS	MIN	TYP	MAX	UNITS	
RECEIVER							
Receiver Differential Threshold Voltage	V_{TH}	$-7V \leq V_{CM} \leq +12V$	-200	-125	-50	mV	
Receiver Input Hysteresis	ΔV_{TH}			25		mV	
Receiver Output High Voltage	V_{OH}	$I_o = -4\text{mA}$, $V_{ID} = -50\text{mV}$	$V_{CC} - 1.5$			V	
Receiver Output Low Voltage	V_{OL}	$I_o = 4\text{mA}$, $V_{ID} = -200\text{mV}$			0.4	V	
Three- State Output Current at Receiver	I_{OZR}	$0.4V \leq V_{CM} \leq 2.4V$			± 1	μA	
Receiver Input Resistance	R_{IN}	$-7V \leq V_{CM} \leq +12V$	96			$\text{k}\Omega$	
Receiver Output Short-Circuit Current	I_{OSR}	Fig.6 , $0V \leq V_{RO} \leq V_{CC}$	± 7		± 95	mA	
SUPPLY CURRENT							
Supply Current	I_{CC}	No load, REB=GND, DI=Vcc or GND.	DE=Vcc		270	600	μA
			DE=GND		220	300	μA
Supply Current in Shutdown Mode	I_{SHDN}	REB=Vcc, DE=GND		1n	10 μ	A	

SWITCHING CHARACTERISTICS

($V_{CC} = 5V \pm 5\%$ with $T_{AMB} = T_{MIN}$ to T_{MAX} , unless otherwise noted. Typical values are at $V_{CC} = 5V$ and $T_{AMB} = 25^\circ\text{C}$.)

PARAMETER	SYMBOL	CONDITIONS	MIN	TYP	MAX	UNITS
Transmitter Input to Output	t_{DPLH} , t_{DPHL}	Fig.2 and 7, $R_{DIFF} = 54\Omega$, $C_{L1} = C_{L2} = 100\text{pF}$	500	980	2600	ns
Transmitter Output Skew $ t_{DPLH} - t_{DPHL} $	t_{DSKEW}	Fig.2 and 7, $R_{DIFF} = 54\Omega$, $C_{L1} = C_{L2} = 100\text{pF}$		-3	± 200	ns
Transmitter Rise or Fall Time	t_{DF} , t_{DR}	Fig.2 and 7, $R_{DIFF} = 54\Omega$, $C_{L1} = C_{L2} = 100\text{pF}$	667	1500	2500	ns
Maximum Data Rate	f_{MAX}		115			kbps
Transmitter Enable to Output Low	t_{DZL}	Fig.4 and 8, $C_{DL} = 100\text{pF}$, S1 closed			1000	ns
Transmitter Enable to Output High	t_{DZH}	Fig.4 and 8, $C_{DL} = 100\text{pF}$, S2 closed			1000	ns

PARAMETER	SYMBOL	CONDITIONS	MIN	TYP	MAX	UNITS
Transmitter Disable Time from Low	t_{DLZ}	Fig.4 and 8, $C_{DL}= 15\text{pF}$, S1 closed			100	ns
Transmitter Disable Time from High	t_{DHZ}	Fig.4 and 8, $C_{DL}= 15\text{pF}$, S2 closed			100	ns
Receiver Input to Output	t_{RPLH}, t_{RPHL}	Fig.5 and 9, $ V_{ID} \geq 2.0\text{V}$; rise and fall time of $V_{ID} \leq 15\text{ns}$		127	200	ns
$ t_{RPLH} - t_{RPHL} $ Different Receiver Skew	t_{RSKD}	Fig.5 and 9, $ V_{ID} \geq 2.0\text{V}$; rise and fall time of $V_{ID} \leq 15\text{ns}$		3	± 30	ns
Receiver Enable to Output Low	t_{RZL}	Fig.3 and 10, $C_{RL}= 100\text{pF}$, S1 closed		20	50	ns
Receiver Enable to Output High	t_{RZH}	Fig.3 and 10, $C_{RL}= 100\text{pF}$, S2 closed		20	50	ns
Receiver Disable Time from Low	t_{RLZ}	Fig.3 and 10, $C_{RL}= 100\text{pF}$, S1 closed		20	50	ns
Receiver Disable Time from High	t_{RHZ}	Fig.3 and 10, $C_{RL}= 100\text{pF}$, S2 closed		20	50	ns
Time to Shutdown	t_{SHDN}		50	200	600	ns
Transmitter Enable from Shutdown to Output Low	$t_{DZL(SHDN)}$	Fig.4 and 8, $C_{DL}= 15\text{pF}$, S1 closed			1000	ns
Transmitter Enable from Shutdown to Output High	$t_{DZH(SHDN)}$	Fig.4 and 8, $C_{DL}= 15\text{pF}$, S2 closed			1000	ns
Receiver Enable from Shutdown to Output Low	$t_{RZL(SHDN)}$	Fig.3 and 10, $C_{RL}= 100\text{pF}$, S1 closed			100	ns
Receiver Enable from Shutdown to Output High	$t_{RZH(SHDN)}$	Fig.3 and 10, $C_{RL}= 100\text{pF}$, S2 closed			2000	ns



($V_{CC} = +5\text{V}$, $T_{AMB} = 25^\circ\text{C}$, unless otherwise noted.)

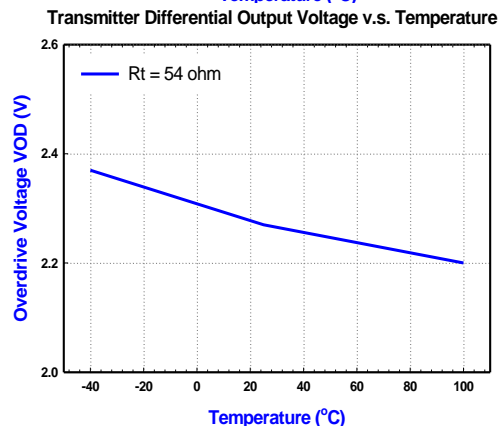
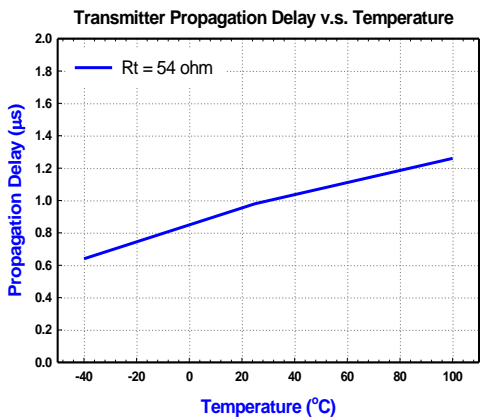
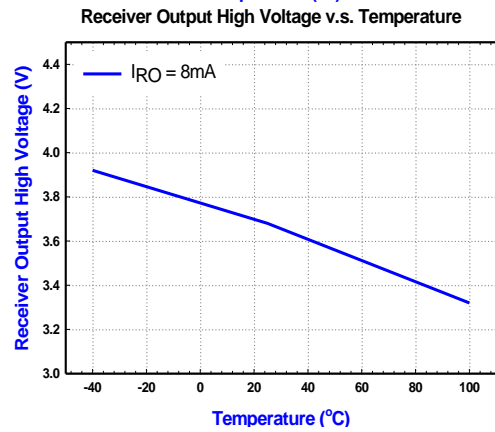
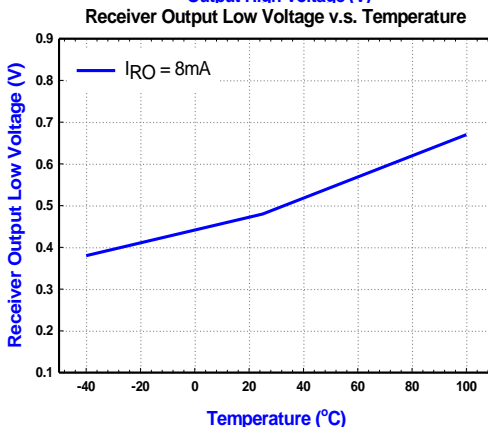
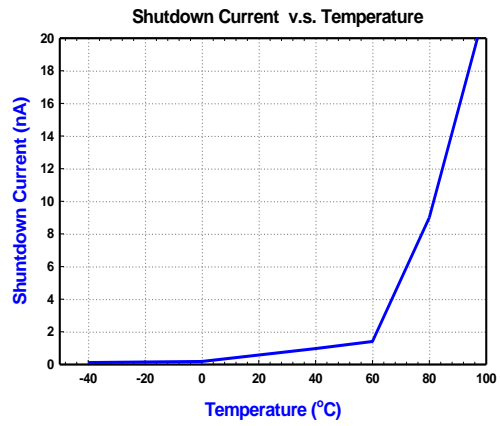
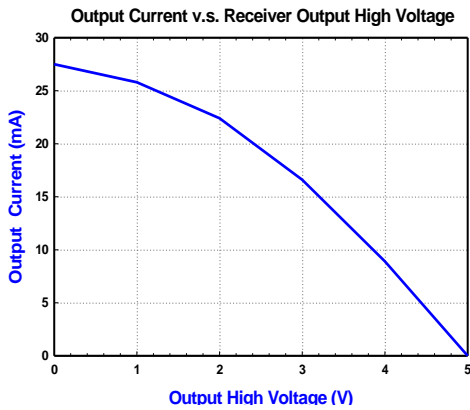
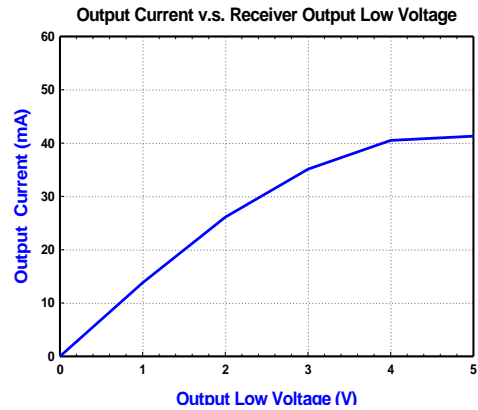
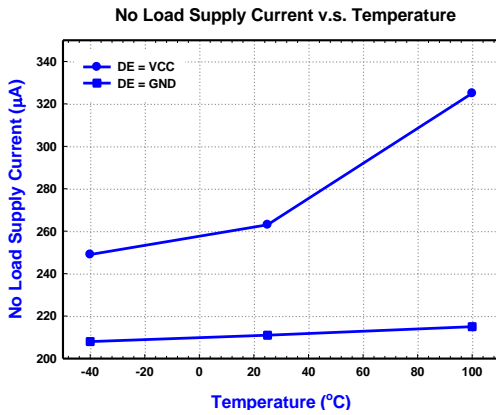

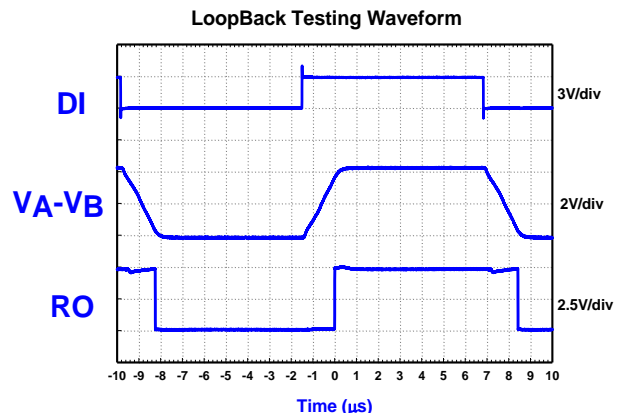
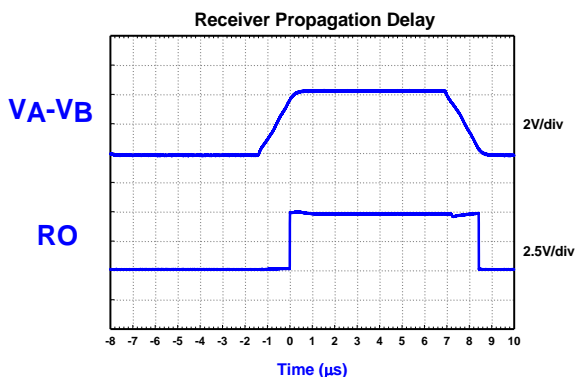
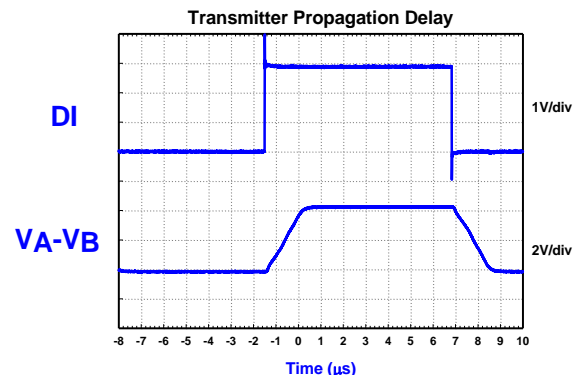
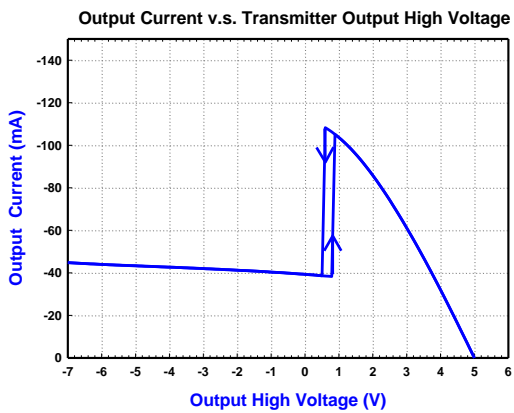
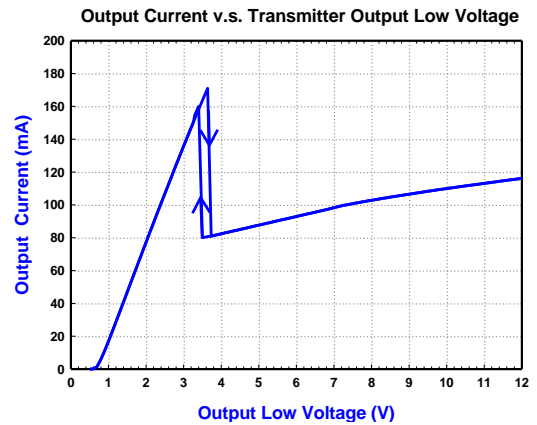
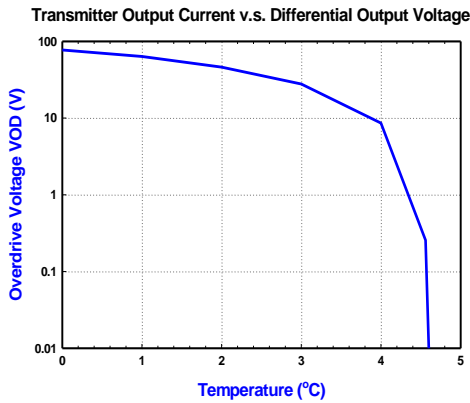



PIN FUNCTION DESCRIPTION

Pin Number	Mnemonic	Function
1	RO	Receiver outputs. When REB is low and if $(A - B) \geq -50\text{mV}$, RO is high; if $(A - B) \leq -200\text{mV}$, RO is low.
2	REB	Receiver Output Enable. Drive REB low to enable receiver; RO is high impedance when REB is high. Drive REB high and DE low to enter shutdown mode.
3	DE	Transmitter Output Enable. Drive DE high to enable transmitter outputs. The outputs of transmitter are high impedance when DE is low. Drive REB high and DE low to enter shutdown mode.
4	DI	Transmitter Input. With DE high, low state of DI forces pin6 (A) to be low and pin7 (B) to be high. Similarly, high state of DI forces pin6 (A) to be high and pin7 (B) to be low.
5	GND	Ground pin. Must be connected to 0V.
6	A	Non-inverting Receiver Input and Non-inverting Transmitter Output
7	B	Inverting Receiver Input and Inverting Transmitter Output
8	VCC	Power Supply 5V.

FUNCTION TABLE

TRANSMITTING				
INPUTS			OUTPUTS	
REB	DE	DI	B	A
X	1	1	0	1
X	1	0	1	0
0	0	X	HIGH-Z	HIGH-Z
1	0	X	SHUTDOWN	

RECEIVING			
INPUTS			OUTPUT
REB	DE	A - B	RO
0	X	≥ -0.05	1
0	X	≤ -0.2	0
0	X	OPEN/ SHORT	1
1	1	X	HIGH-Z
1	0	X	SHUTDOWN

X
= Don't care

SHUTDOWN
= Receiver and Transmitter Output high impedance

High-Z
= High Impedance State

Detail Description

The AZRS3082 is a half-duplex RS-485 transceiver, which contains one transmitter and one receiver with 5V power supply. This device is fully compliant with the EIA/TIA-485 standard.

The AZRS3082 features a fail-safe receiver, which guarantees the receiver output high when the receiver inputs are open, short or idle. The AZRS3082 features the slew-rate-limited transmitter to minimize EMI and reflection by improperly cable terminated, which allowed error-free data transmission up to 115kbps. The hot-swap circuits guarantees the outputs of the transceiver in a high impedance state during the power up period. The thermal shutdown function and the transmitter current limited function protect the device from damage of system fault conditions.

Transmitter

The design of the transmitter is a non-inverted translator that converts the single-ended input signal to differential EIA/TIA-485 signal level. The transmitter of the AZRS3082 guarantees a 115kbps data rate communication with limited slew rate of output signal to minimize EMI and reduce improperly terminated cable reflection. When the transmitter is active (DE= HIGH), the single-end input signals of transmitter will be transported to differential output signals of the transmitter. Under the disable state (DE= LOW), the outputs of transmitter are stay at high impedance state.

Receiver

The receiver of the AZRS3082 converts the differential EIA/TIA-485 signals to single-end output TTL signal when receiver is in active state (REB=LOW), which incorporates input filtering in addition to input hysteresis, which enhances noise immunity with differential signals that have very slow rise and fall times.

Fail-Safe

The AZRS3082 guarantees a receiver output high when the receiver inputs are short, open, or idle. The threshold voltage of receiver input is between -50mV and -200mV . If the differential receiver input voltage (A - B) is greater than or equal to -50mV , receiver output (RO) is logic-high. If (A - B) is less than or equal to -200mV , RO is logic-low. In the case of a terminated bus with all transmitters disabled, the receiver's differential input voltage (A - B) is 0V; therefore, the RO is logic-high at that time.

Transmitter Output Protection

The AZRS3082 has the current limitation function and the thermal shutdown protection in the transmitter. Firstly, the function of current limitation provides immediate protection against short circuits over the whole common-mode voltage range (-7V to $+12\text{V}$). Secondly, the function of thermal shutdown protection will be active to force the transmitter outputs into a high impedance state if the operating temperature is over 150°C .

1/8 Unit Load

The RS-485 standard defines both receiver inputs impedance are $12\text{k}\Omega$ (1 unit load) and the maximum 32-unit loads on the bus. The AZRS3082 transceiver has a $96\text{k}\Omega$ input impedance (1/8 unit load) of the receiver, allowing up to 256 devices to be connected in parallel on the RS485 bus.

Reduced EMI and Reflections

The AZRS3082 features the function of a slew-rate-limited transmitter that minimizes EMI and reduces reflections caused by improperly terminated cables, which allows the error-free data transmission up to 115kbps.

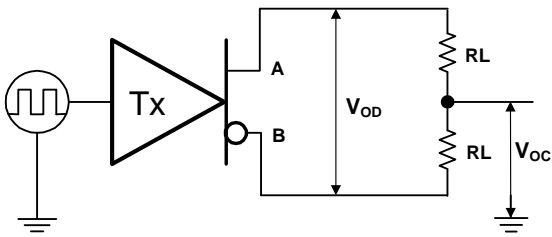

Fig.1 Transmitter DC test circuit

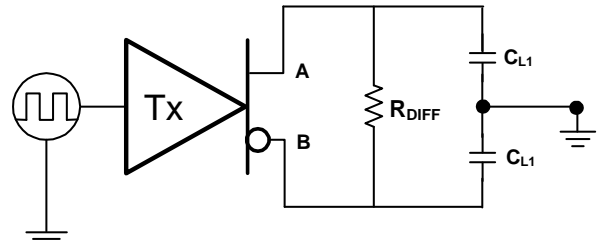

Fig.2 Transmitter timing test circuit

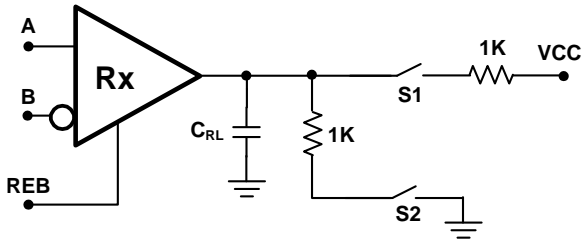

Fig.3 Receiver enable/disable timing test load

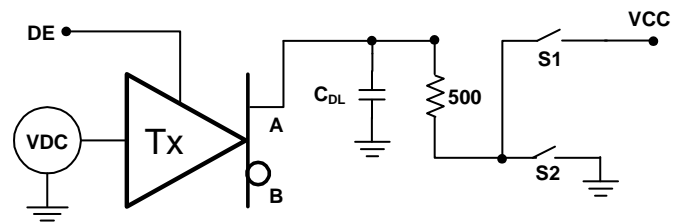

Fig.4 Transmitter enable/disable timing test load

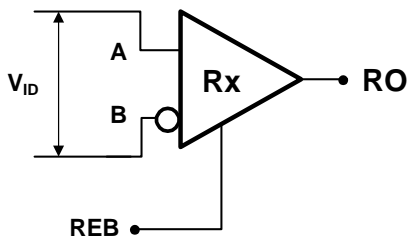

Fig.5 Receiver timing test circuit

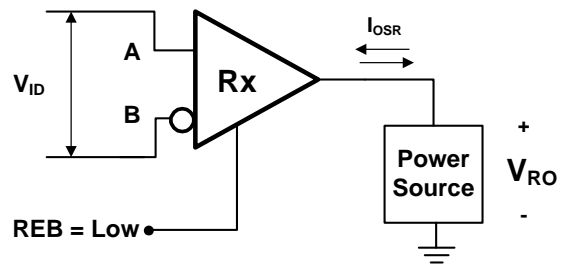

Fig.6 Receiver output short circuit

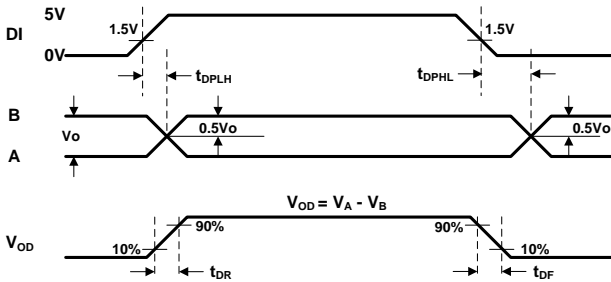

Fig.7 Transmitter Propagation Delays

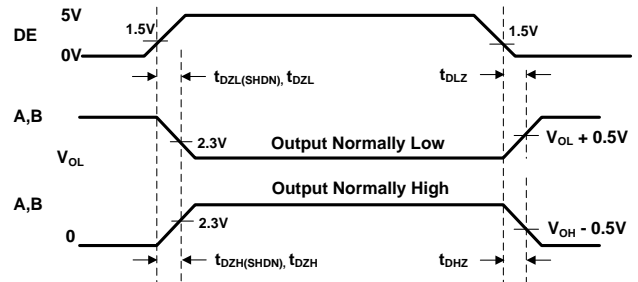

Fig.8 Transmitter Enable and Disable Times

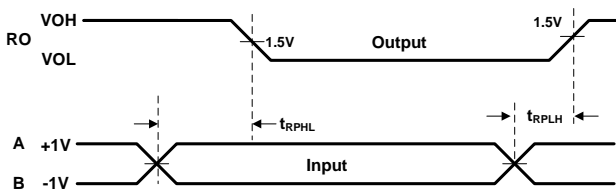

Fig.9 Receiver Propagation Delays

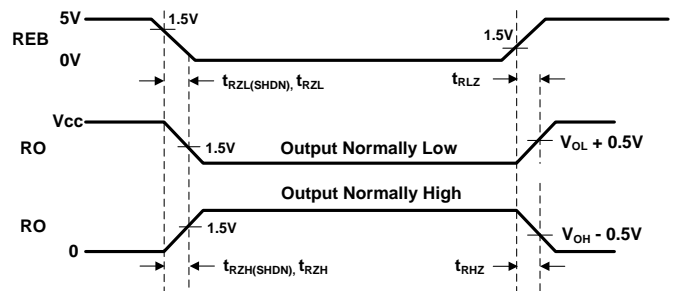
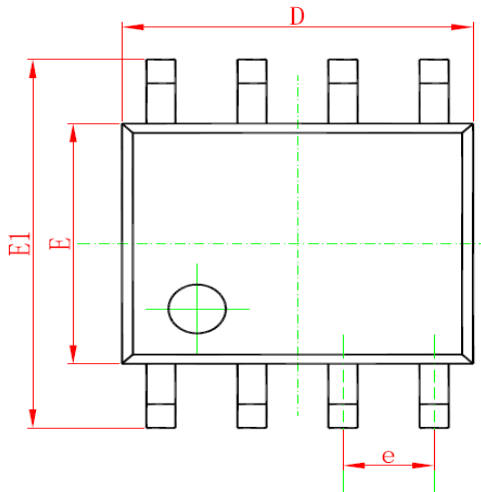

Fig.10 Receiver Enable and Disable Times

Mechanical Details

SO-8
PACKAGE DIAGRAMS
TOP VIEW



SIDE VIEW

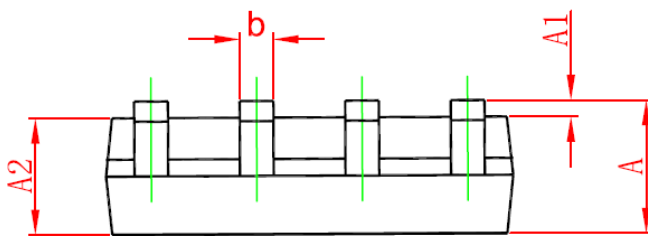

END VIEW

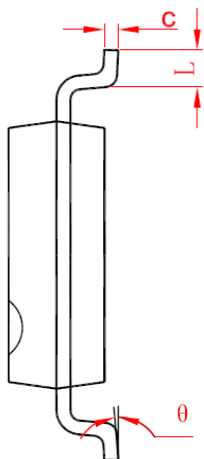

PACKAGE DIMENSIONS

Symbol	Millimeters		Inches	
	min	max	min	max
A	1.35	1.75	0.053	0.069
A1	0.10	0.25	0.004	0.010
A2	1.35	1.55	0.053	0.061
b	0.33	0.51	0.013	0.020
C	0.17	0.26	0.007	0.010
D	4.70	5.10	0.185	0.201
E	3.70	4.10	0.146	0.161
E1	5.80	6.20	0.228	0.244
e	1.27 BSC		0.05BSC	
L	0.40	1.27	0.016	0.050
θ	0	8	0	8

MARKING CODE

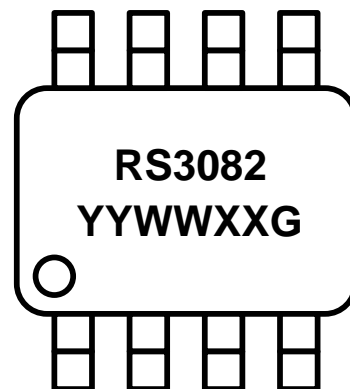

RS3082 = Device Code

YYWW = Date Code

XX = Control Code

G = Green Part Indication

Part Number	Marking Code
AZRS3082	RS3082 YYWWXXG



Ordering Information

PN#	Material	Type	Reel size	MOQ/interal box	MOQ/carton
AZRS3082.RDG	Green	T/R	13 inch	1 reel=2,500/box	5 box=12,500/carton

Revision History

Revision	Modification Description
Revision 2010/01/05	Preliminary Release
Revision 2010/03/25	Formal Datasheet Release
Revision 2010/04/02	Update the PACKAGE DIMENSIONS.
Revision 2011/03/21	Correct the Package type from SOP-8 to SO-8.
Revision 2011/06/19	1. Update the Company Logo. 2. Add the Ordering Information. 3. Eliminate the index of L1 in the PACKAGE DIMENSIONS.
Revision 2016/05/06	Modified the indication of Marking code.